

- (A) Colector drenaje 1"  
**1" Drainage manifold**
- (B) Colector entrada 3"  
**3" Inlet manifold**
- (C) Colector salida 3"  
**3" Outlet manifold**

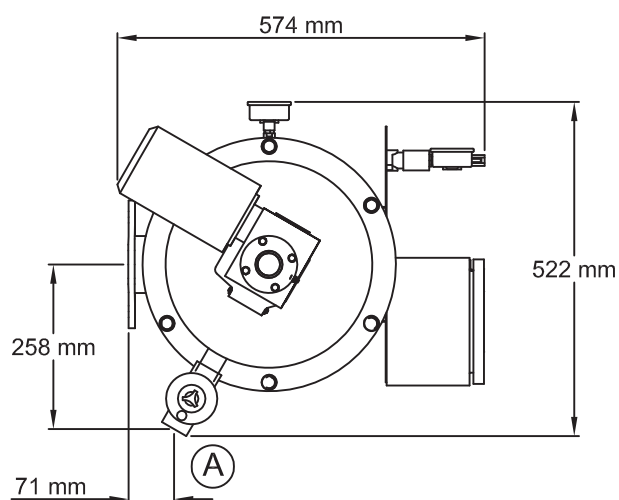

### AZUD LUXON LDB 1000 S/3

SCALE S/E A4 FORMAT	MATERIAL:	RESPONS.: M. Martínez	<b>AZUD</b>
	UNITS: mm.	REVISION: 00	
	FILE: Azud_luxon_LDB_1000-S3.dwg	12/04/2012	